

Introduction

Congratulations and thank you for purchasing your Rutland 1200 Wind Turbine and Hybrid MPPT Charge Controller. Our range of Rutland Wind Turbines are renowned as reliable, quiet and efficient in service and have been used worldwide by sailors and many off-grid power specialists since 1979.

The utmost of care goes into the manufacture of all our products in our ISO9001 approved factory. To ensure you get the very best out of the Rutland 1200 we recommend that you read this manual and familiarise yourself with its contents before installing and operating the wind turbine and charging system.

How to Use This Manual

There are 2 parts to this manual, we recommend installing the controller and wiring followed by the turbine before final commissioning. Visit www.marlec.co.uk/support to see useful video installation and operating guides.

General Guidelines and Warnings

Safety is the primary concern during both installation and operation of your wind turbine. You should familiarise yourself with the risks associated with electrical and mechanical installation and if in doubt seek professional advice. The key safety risk factors to be assessed are:

⚠ The rotating turbine

- Install the turbine at a location and height where persons cannot interfere with the path of the blades. No attempt to access the turbine should be made until it has been restrained from turning, if possible lower the tower to ground level.
- Use the electronic stall switches to stop power production of both the turbine and solar panel. The turbine speed will eventually reduce to an idle for safer access.
- Caution: The aerofoil blades are very sharp, gloves are recommended for handling and every precaution must be made to avoid them in rotation as there is risk of harm to persons if struck.

⚠ Handling DC voltages and batteries

- Never allow the wind turbine or a solar panel to generate electricity without connection to a battery. Cover solar panels and lower or stop the turbine, short circuit them to prevent operation.
- Do not make live connections to controllers or batteries as high open circuit voltages will permanently damage electronics.
- Observe correct polarity to avoid permanent damage to equipment.
- Do not open electronic equipment during live operation.
- Always use cable suitable for carrying the expected currents and ensure good quality electrical connections to avoid arcing and fire risks.
- Damages as a consequence of failure to follow these guidelines will invalidate the warranty.

⚠ Working at height—use suitable equipment. Effect as much of the installation at ground level as possible and choose a calm day to install the turbine.

If in doubt refer to your dealer, a competent electrical engineer or the manufacturer.

Inspection and Maintenance

The Rutland Wind Turbine requires no scheduled maintenance. An annual inspection should be undertaken to monitor the general condition of the system to ensure the electrical and mechanical integrity and safety of the system. For advice and troubleshooting visit www.marlec.co.uk or watch our videos at YouTube/MarlecTV

For Your Records—you will need this if you contact us

Serial Number of Rutland 1200 Turbine	
Serial Number of Rutland 1200 Controller	
Date of Purchase and Sellers Name	
Date of Installation	

Read in conjunction with Part 2 Rutland 1200 Controller Installation manual. Find more information at www.marlec.co.uk

Limited Warranty

The Marlec Engineering Company Limited Warranty provides free replacement cover for all defects in parts and workmanship for 24 months from the date of purchase. Marlec's obligation in this respect is limited to replacing parts which have been promptly reported to the seller and are in the seller's opinion defective and so found by Marlec upon inspection. A valid proof of purchase is required if making a warranty claim.

Defective parts must be returned by prepaid post to the manufacturer Marlec Engineering Co Ltd, Rutland House, Trevithick Rd, Corby, Northamptonshire, NN17 5XY, England or to an authorised Marlec agent.

This Warranty is invalid in the event of improper installation, owner neglect, mis-use, damage caused by flying debris or natural disasters including lightning strike and hurricane force winds. This Warranty does not extend to support posts, inverters, batteries or ancillary equipment not supplied by the manufacturer.

No responsibility is assumed for incidental damage. No responsibility is assumed for consequential damage or loss. No responsibility is assumed for damage caused by user modification to the product or the use of unauthorised components.

Manufactured in the UK by
Marlec Eng Co Ltd
Rutland House, Trevithick Rd, Corby, NN17 5XY
www.marlec.co.uk sales@marlec.co.uk

Doc No: SM-469 Iss D Part 1 20.03.17



<p>Check you have received:</p> <ul style="list-style-type: none"> 1 x Rutland 1200 Wind turbine with fixings 1 x Hybrid MPPT Charge Controller with External Temperature Sensor 	<p>Tools Required</p> <ul style="list-style-type: none"> 10mm & 17mm Spanner PZ1 & PZ2 Crosshead Screwdrivers Terminal Screwdriver Wire Strippers Multi-meter (useful)
<p>Other items you may require</p> <ul style="list-style-type: none"> Tower / Mounting Pole Connection Cables & Connector Blocks Deep Cycle Batteries & Terminals Controller Fixing Screws Solar PV Panels & Diodes 	

In the event of loss or damage consult your dealer or the manufacturer.

Siting the Turbine

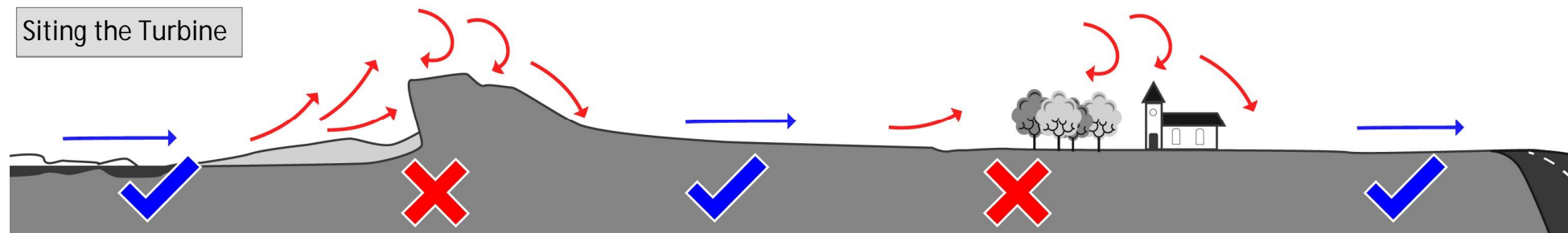

The smooth flow of wind over land and water is often interrupted by a multitude of obstructions causing wind shear and turbulence. The location and height of the mounting pole or tower for the wind turbine will be the major factor in the overall performance and lifetime of the system. Wind speeds decrease and turbulence increases where obstructions exist so the siting of the turbine is very important to ensure good yields and turbine lifetime. On yachts, the open water will deliver better yields than in typically sheltered marinas.

Turbine Dimensions

Turbine Orientation
The Rutland 1200 is designed for use in the orientation shown in this manual it should not be installed and operated upside down.

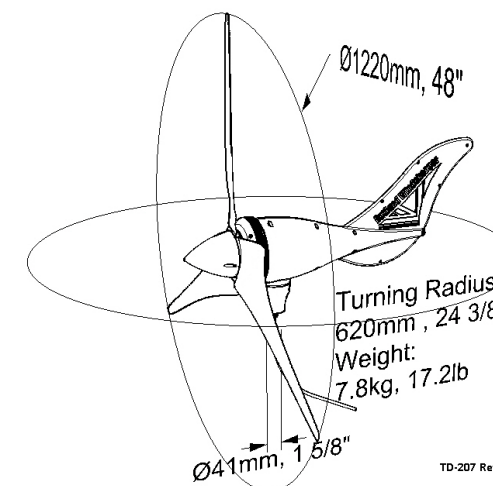

Tower Selection

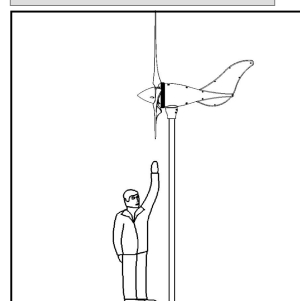

On Board Systems

The Wind Turbine should be mounted in a safe position, a minimum of 2.7 metres above the deck and away from other obstacles which could interfere with the blades or tail assembly.

The pole should be supported to maintain it in the upright position against lateral movement in high winds.

The Rutland Marine Mounting Kit & Stays Kits are available for deck mounting. We suggest the following mountings according to preference:

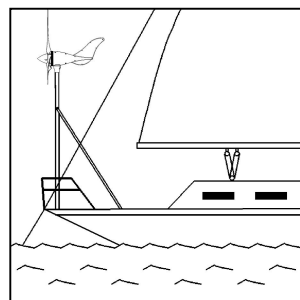

Push Pit

A suitable pole mounted to the deck with deck plates and stays is the most popular method of mounting the wind turbine on yachts, eg. Rutland Marine Mounting & Stays Kit

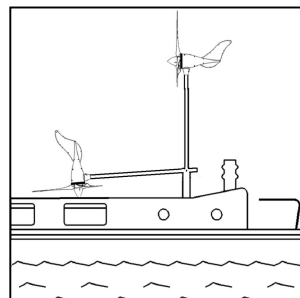

River Boats

A pivot pole is ideal for riverboats as this enables the turbine to be easily raised and lowered. Rigid stays are required to support the upright pole.

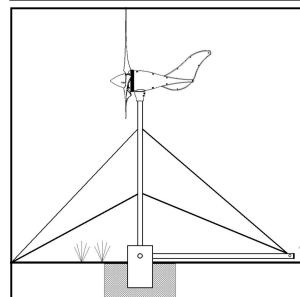

Land Based Systems

For good performance mount the Rutland 1200 at a minimum of 6m above ground level following the siting guidelines.

Pivot type towers are suggested for ease of raise and lowering. Performance is impaired if the tower is not maintained vertical in operation.

Base Pivot Tower

A tower can be erected using a 6.5 metre (21 feet) galvanised (medium) tube and must be supported by a minimum of two sets of four guy lines. The Marlec Land Tower & Tower Rigging Kit are available at www.marlec.co.uk

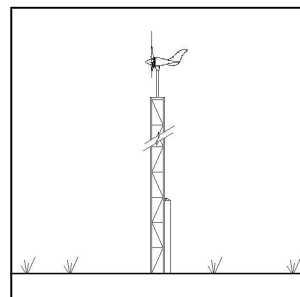

Freestanding Tower

Lattice or other types of freestanding columns can be selected. Ensure that all loadings are calculated.

Assemble and Install the Turbine

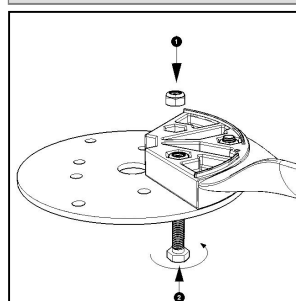

Rotor Blade Assembly

1. Place a M6 Nylock nut into the nut recess in the aerofoil blade.
 2. Align with a hole in the Rotor Hub Plate and partly tighten a M6 screw in from the back of the plate. Repeat with 3 fasteners on all 3 blades.
- Caution - All 9 screws must be fitted!

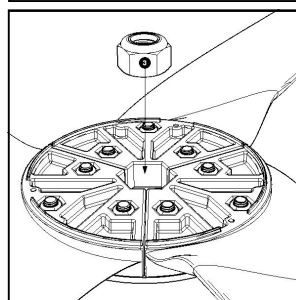

Fit the Main Shaft Nut

1. Fit the M16 Nylock nut (supplied pre-greased) into the recess created by the 3 blades.
2. Finish tightening the M6 blade screws using a 10mm spanner from the back of the Rotor Hub Plate. Hold the blades near the root to avoid damaging the aerofoils. Check tightness of all screws but do not over-tighten.

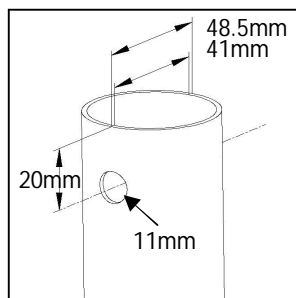

Fitting the Rutland 1200 to the Tower

Select an aluminium or stainless steel tube. Internal diameter 41mm (1 1/2"). For blade clearance the pole must not exceed 48.5mm (2") outside diameter for the top 0.6m. Drill 2 holes diametrically opposite as shown.

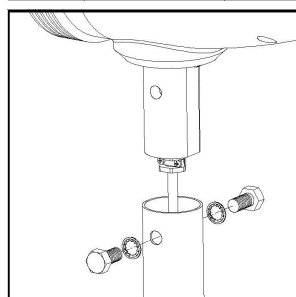

Connect the Cables - See table in Manual Part 2

1. Thread the 3 core turbine cable through the pole allowing at least 1m of extra cable for lifting the turbine on and off.
2. Strip back 10mm of the wind turbine and tower cables. Join them using the 3-way connector block. Wrap the connection with insulation tape to secure and protect from the environment. *Alternatively join the cables using a latching plug and socket.* Loop back the cable and secure with a cable tie to provide strain relief to the joint.
3. Coat the post adaptor with petroleum jelly to protect it.
4. Carefully push the cables down the pole as you slide the post adaptor into position, lining up the screw holes.
5. Secure in place with the M10 screws and shake-proof washers using a 17mm spanner. Tighten up to the shake-proof washer finishing with the head in either of the positions shown ready for fitting the pole fairing.

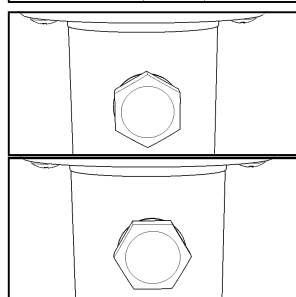

Fit the Turbine to the Generator

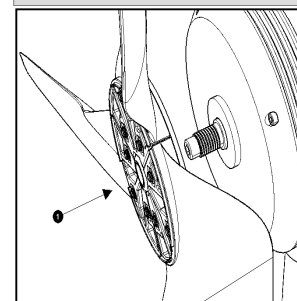

1. Offer up the rotor blade assembly to the generator and place the greased M16 Nylock nut at the centre over the windshaft. Hold the blades near the root to avoid damaging the aerofoils. CAUTION: The blades are sharp.

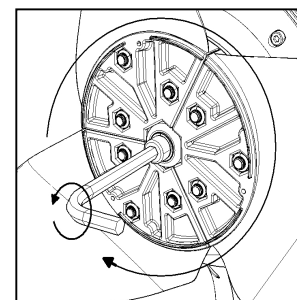

2. Carefully start to screw the rotor blade assembly onto the windshaft by turning it clockwise. When engaged place the 6mm Allen key provided at the centre of the shaft and hold this firmly as you continue to screw the rotor to full tightness. IMPORTANT: Ensure the turbine hub plate is squarely located on the shaft's shoulder.

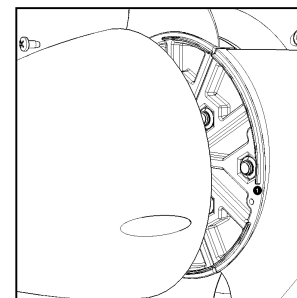

At this time you should restrain the turbine from turning or keep the mounting pole lowered. If the cable is already connected to the controller the turbine will be prevented from turning.

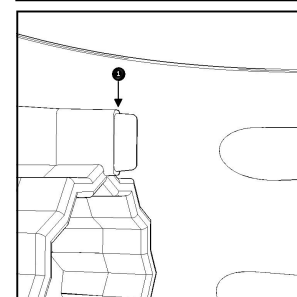

Fit the Nose Cone

1. Locate the nose cone over the rib on the rotor blade assembly and align the 3 screw holes.
2. Secure nose cone using the 3 No3x10 Plastech screws and a PZ1 screwdriver.

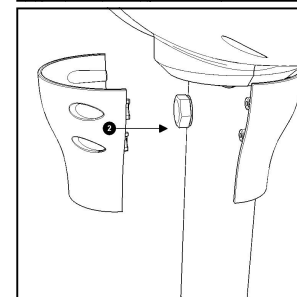

Fit the Pole Fairing

- Note: For thick wall poles the tab on the inside of the fairings should be trimmed back to the step as indicated.
1. Push the Pole Fairing over the M10 Hex head. This also acts as a locking device.
 2. Screw together the pole fairing using the 4 No3.5x10 Plastech screws and a PZ2 screwdriver.

Commissioning

Before raising the tower or allowing the turbine to rotate follow the Commissioning section in the Manual Part 2